

INTERSECTOR™ LED LIGHT

#ENT2B3(x) Single Light Kit
 #ENT2B3(x)-EU Single Light Kit w/ Xylex Lens

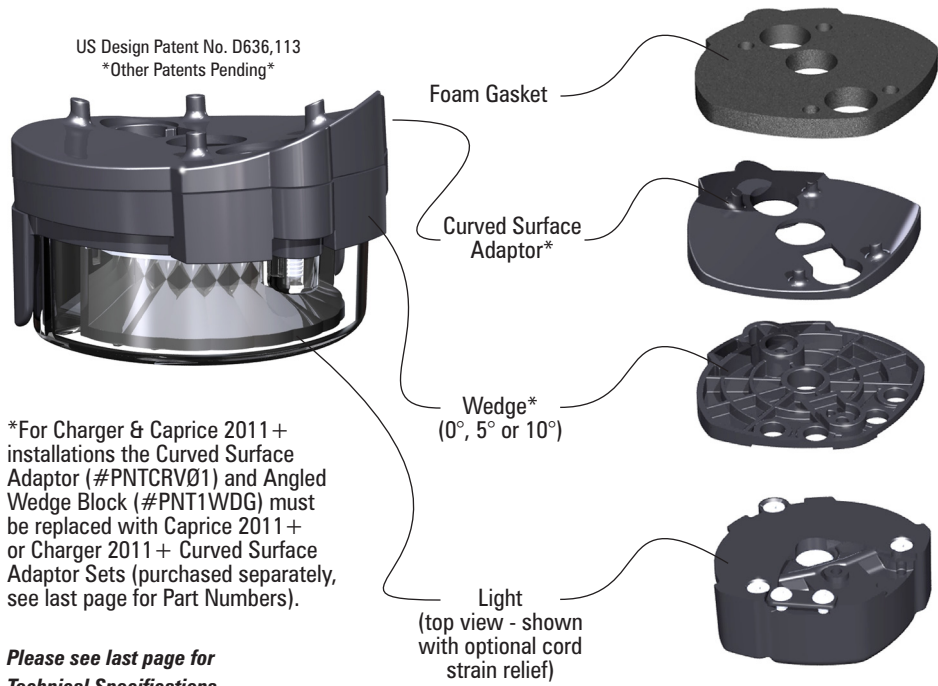

US Design Patent No. D636,113
 Other Patents Pending

*For Charger & Caprice 2011+ installations the Curved Surface Adaptor (#PNTCRV01) and Angled Wedge Block (#PNT1WDG) must be replaced with Caprice 2011+ or Charger 2011+ Curved Surface Adaptor Sets (purchased separately, see last page for Part Numbers).

Please see last page for Technical Specifications

Important Information:

- Warning devices are strictly regulated and governed by Federal, State and Municipal ordinances. These devices shall be used ONLY on approved vehicles. It is the sole responsibility of the user of these devices to ensure compliance.
- DO NOT install this product or route any wires in the Air Bag Deployment Zone. Refer to your vehicle Owner's Manual for the location of any air bag deployment zones.
- DO NOT connect this device to a strobe power supply. This product is self-contained and does not require an external power supply.

The Intersector™ LED Light is designed to be mounted under the vehicle's side mirrors and provide a warning signal to the front and sides. It can also be surface mounted.

INSTALLATION:

Loosely assemble Intersector™ Light, correct wedge block and curve block (P=Passenger, D=Driver's side, Crown Vic and Dodge Charger only) and position assembly below side rear view mirror as shown at left.

Carefully remove light from stack without changing position of wedge block. Mark and drill pilot holes for #6 sheet metal screw.

Drill $\varnothing 3/8"$ hole in mirror shell if wire is to be routed internally. If wire will be routed external of the mirror shell this step can be ignored.

Dismount mirror from door.

The following is particular to the Ford Crown Vic but can be applied to other vehicles as well:

After pilot holes for #6 sheet metal screws are drilled, a $\varnothing 3/8"$ bit should be used to drill hole in race way next to mirror power race. A $\varnothing 3/8"$ hole should then be made between the pilot holes and then angled toward the race way as shown in Figures 2-6 (second page). It is important to avoid drilling through the power cable as this will damage the mirror.

Using #6 machine screw, washer and square nut assemble light and appropriate wedge block, curve block (if required) and gasket. Route wire carefully through $3/8"$ hole and into door. Use appropriate #6 sheet metal screws to attach light to underside of mirror. **DO NOT OVERTIGHTEN SCREWS AS THIS MAY DAMAGE THE MIRROR OR LIGHT.** Mirror may now be replaced on vehicle.

Attach supplied female connector and make other appropriate wiring connections inside of door.

OPERATION:

For details on operation see page with 'Flash Patterns' table on last page.

IMPORTANT:

Power should only be supplied through RED WIRE of flasher harness and must be fused with a 3A, user supplied, in-line fuse. Failure to install this fuse will create a fire hazard and will damage the Intersector™ Light. Connecting the Intersector™ light to any power source directly **WILL** permanently damage the light and will void warranty.

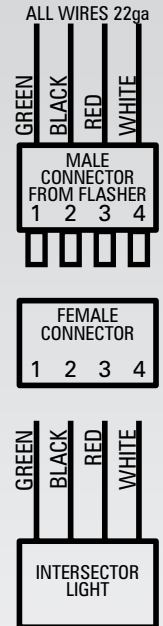

IMPORTANT! FOR PROPER OPERATION ALL WIRES MUST BE CONNECTED FROM FLASHER TO LIGHT HEAD.

WIRE HOOK-UP TABLE

WIRE COLOR: (ALL WIRES 20ga)	CONNECT TO: (FROM FLASHER ONLY)
RED	+10-16 Vdc
WHITE	Pattern Select / Sync
BLACK	Ground (-)
GREEN	Cruise Mode (+10-16 Vdc)

⚠ WARNING
 This product contains high intensity LED devices. To prevent eye damage, DO NOT stare into the light beam at close range.

INTERSECTOR™ LED LIGHT

#ENT2B3(x) Single Light Kit
 #ENT2B3(x)-EU Single Light Kit w/ Xylex Lens

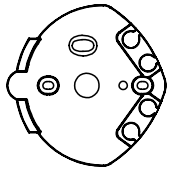

UTILITY BLOCK
 0° (HORIZONTAL)*

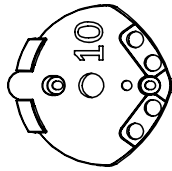

WEDGE BLOCKS
 10° FOR TAHOE*

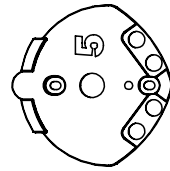

5° FOR CROWN
 VIC, IMPALA AND
 CHARGER*

* INDICATES FOR WHAT PART WAS DESIGNED. INSTALLATION
 ON OTHER VEHICLES IS INSTALLER'S RESPONSIBILITY.

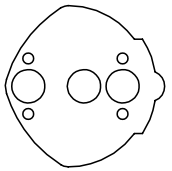

GASKET

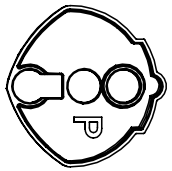

CURVED SURFACE ADAPTOR
 (CROWN VIC OR CHARGER)
 P=PASSENGER SIDE
 D=DRIVER SIDE

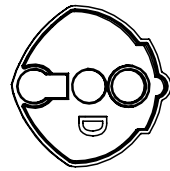

DEGREE DESIGNATION IS EMBOSSED IN PART



PASSENGER OR
 DRIVER SIDE
 DESIGNATION IS
 EMBOSSED IN PART

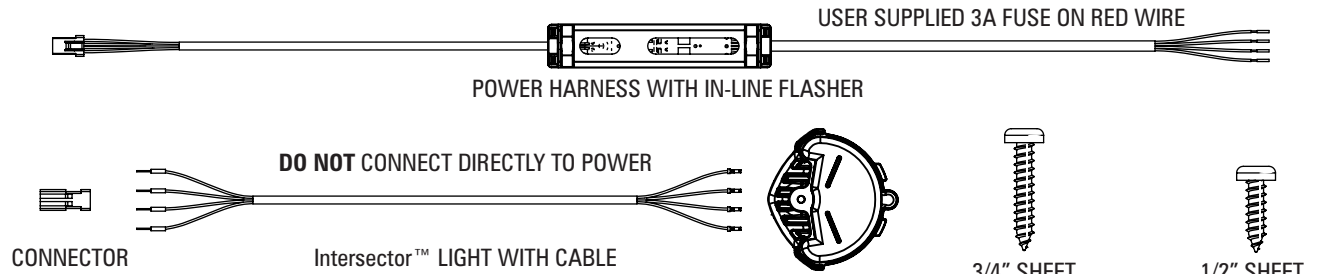

USE TO JOIN LIGHT TO WEDGE BLOCK AFTER
 CORD EXIT IS DETERMINED

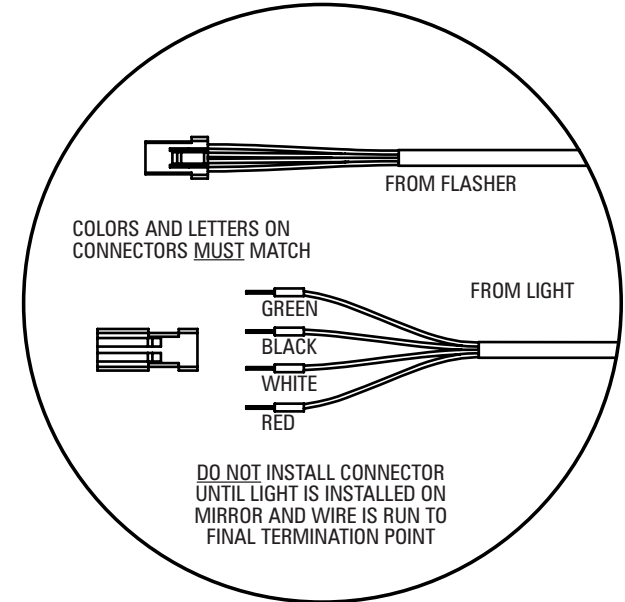
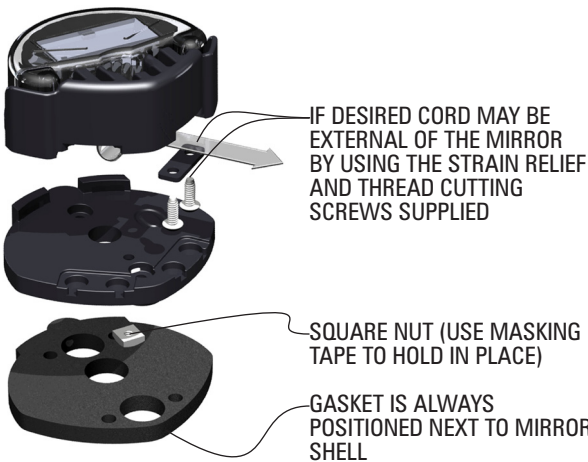
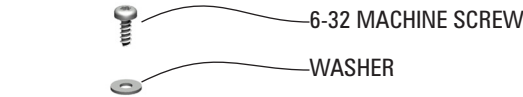
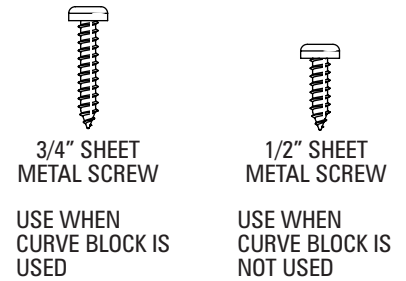

IMPORTANT! FOR PROPER OPERATION ALL WIRES (INCLUDING GREEN WIRE) MUST BE CONNECTED FROM FLASHER TO LIGHT HEAD.

INTERSECTOR™ LED LIGHT

#ENT2B3(x) Single Light Kit
 #ENT2B3(x)-EU Single Light Kit w/ Xylex Lens

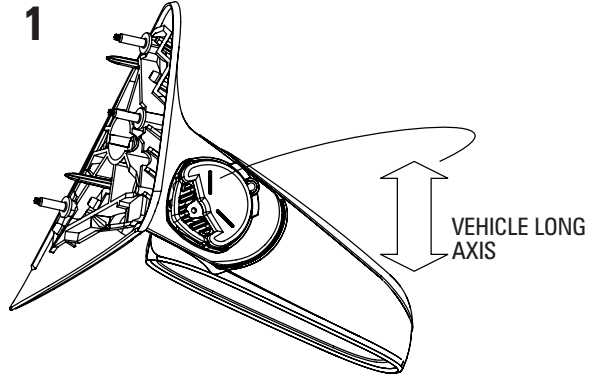

Light should be positioned so that raised lines on lens is aligned with long axis of vehicle.



Drilling of inner part is only required on Crown Vic.





INTERSECTOR™ LED LIGHT

#ENT2B3(x) Single Light Kit
 #ENT2B3(x)-EU Single Light Kit w/ Xylex Lens

PATTERN RESET

1. Remove power.
2. Place WHITE (sync) wire to ground.
3. With sync wire grounded, re-power RED wire.
4. Maintain for one second (light will dim).
5. Remove power and ground (pattern 1 set).

Tech Specs	Intersector™
Flash Patterns:	30 Flash Patterns
Light Sync:	Yes
Technology:	9 Gen3 LEDs
Mounting:	Under Mirror & Surface Mounts
Input Voltage:	10 - 16 Vdc
Current Draw:	less than 1.5 amps
Dimensions:	Width x Height x Depth 2.9" (74 mm) W x 1.9" (48 mm) H x 2.9" (74 mm) D
Operating Temp.:	-40° to +65° C / -104° to +149° F
Patents:	US Design Patent No. D636,113 *Other Patents Pending*

Parts & Accessories:

In-line Flasher #PNT2FLA
 Univ. Curved Surface Adaptors #PNT1CRV01 (pair)
 Chevrolet Caprice Adaptors #PNT1CRV02 (pair)
 Dodge Charger Adaptors #PNT1CRV03 (pair)
 Wedges (0°, 5° & 10°) #PNT1WDG (set of 3)
 Intersector™ (light only) #PNT2B0(x)



SINGLE LIGHT HEAD SET UP AND PATTERN SELECTION

1. Disconnect WHITE wire from any connections if applicable.
2. Turn Intersector™ LED LIGHT ON by applying power to RED WIRE from flasher. **IMPORTANT NOTE:** Power harness with in-line flasher (PNT(x)FLA) **MUST** be used between power and light. **Any other flasher WILL cause permanent damage and void warranty.**
3. Momentarily touching and removing the WHITE wire to ground will advance the Intersector™ LED LIGHT to the next flash pattern. Touching and removing the WHITE wire for more than a few seconds will allow you to change the Intersector™ LED LIGHT to the previous pattern. See flash pattern table. Continuing to touch and remove the WHITE wire to ground will allow you to scroll through the pattern list. After pattern #30 is reached the list will start over again at pattern #1.

SINGLE COLOR CONFIGURATIONS

Follow the ID selection steps and set the Intersector™ LED LIGHT to the following ID:

ID #2 - Single Color ID #4 - Single Color

Single Color - Simultaneous Flash Patterns:
 - Set light heads to same ID (#2 or #4).

Single Color - Alternating Flash Patterns:
 - Set one light head to ID #2 and another to ID #4.

MULTIPLE LIGHT HEAD SET UP AND PATTERN SELECTION

1. Set ID#
 - a. Connections
 - i. RED: +10-16Vdc
 - ii. WHITE: +10-16Vdc (Note: you will need to disconnect after power is applied)
 - iii. BLK: Ground
 - iv. GREEN: NO CONNECTION REQUIRED FOR ID SELECTION
 - b. Apply power to unit
 - c. Without disconnecting power from unit, disconnect WHITE wire
 - d. Momentarily connect WHITE to Ground to change ID #
 - i. Identify ID# by number of sequential flashes
 - ii. Possible ID#s: 2 or 4
 - e. Disconnect Power to exit ID mode
2. Set Pattern - Must be done individually to each light prior to syncing
 - a. RED: +10-16Vdc
 - b. BLACK: Ground
 - c. While light is powered, tap WHITE wire to ground to advance to the next pattern (SEE pattern table at right)
 - d. Disconnect Power
3. Sync Lights
 - a. Once desired pattern has been selected for all light heads connect all white wires and insulate with electrical tape.
4. Connect Master Switch for Application.

Flash Patterns				
Pattern Name	1 Light	Alternating 2 Lights	Simultaneous 2 Lights	F.P.M. (Flashes / Minute)
1. Quint	x	x	x	70
2. Warp	x	x	x	350
3. Inter-Cycle Flash	x	x		
4. Double Flash	x	x	x	70
5. Quad Flash	x	x	x	80
6. PowerPulse™	x	x	x	180
7. RoadRunner™	x	x	x	113
8. Q-Switch™	x	x		
9. RoadRunner™ Steady Burn	x	x		113
10. Quad Steady Burn	x	x		80
11. E-Ideal Single Flash	x	x	x	200
12. E-Ideal Double Flash	x	x	x	146
13. Quad2 Flash	x	x	x	67
14. Double2 Flash	x	x	x	95
15. PowerRunner	x	x	x	
16. LCR Quint	x	x	x	
17. Warp ³	x	x	x	
18. Ultra Warp	x	x	x	545
19. Thunder & Lightning	x	x		
20. Lite Speed	x	x	x	85
21. SuperSonic	x		x	170
22. LCR Lite Speed	x	x	x	
23. SuperSonic Ultra	x	x	x	
24. Tempo Shift	x	x	x	
25. Tempo Shift Warp	x	x	x	
26. SBE2	x	x	x	67
27. C ²	x	x	x	200
28. U ²	x	x	x	176
29. Cyclone2	x	x	x	
30. Chameleon2	x	x	x	